

No. 2 September 2001  
1<sup>st</sup> edition



# ***FiBL* DOSSIER**

## **Plant Breeding Techniques**

### **An Evaluation for Organic Plant Breeding**

In cooperation with:



Soil Association



**Bioland**  
ÖKOLOGISCHER LANDBAU

**Seeds form the basis for agricultural production, but most organic growers know little about how their seedstocks have been produced. Within the organic movement the discussion on the compatibility of plant breeding techniques has been accelerated by the public discussion on genetic engineering. This decision-making is important to develop a framework for organic plant breeding and facilitate investment by breeding companies.**

**This dossier explains all standard techniques used in modern plant breeding and why they have been developed. The consequences of not allowing certain techniques for organic plant breeding are outlined, along with suggestions for alternative techniques that could be adopted.**

# Introduction

It is important that breeding, multiplication, and maintenance techniques are identified and examined to assess their compatibility with the technical, ethical and environmental objectives of organic agriculture. This process will assist the ongoing national and international discussions on this topic and will also be of value in light of the requirement for all organic producers to use organic seed by 2004 (EU Regulation 2092/91).

The issue of plant breeding techniques and their compatibility with organic farming is complex due to the range of techniques available balanced against the different demands for variety and crop performance. Appropriate organic plant breeding will serve to develop improved varieties for organic systems without jeopardising the ethical and environmental integrity of organic agriculture.

Currently, only the use of varieties obtained by genetic engineering is forbidden in organic agriculture across Europe (EU Regulation 2092/91). The regulation requires also that parent plants of annual crops have to be grown at least for one generation under organic conditions, while biannual plants and perennials have to be grown for at least two generations under organic conditions. Figure 1 should help to understand the definition of «organic seeds» and «organic varieties» and to distinguish the different levels of breeding, maintenance, and multiplication.

The aim of this dossier is to provide information on plant breeding techniques currently used to help the debate shaping the future of organic plant breeding. Therefore, the mechanism of standard breeding and multiplication techniques is explained with the aid of simple graphics. In addition, the actual application, the consequences of a rejection of a technique and the alternatives are described. As a guideline for determining the suitability of breeding and multiplication techniques for organic breeding, criteria are formulated in the last part of this dossier.

**Figure 1: Overview on the different levels of breeding, maintenance, and multiplication.**

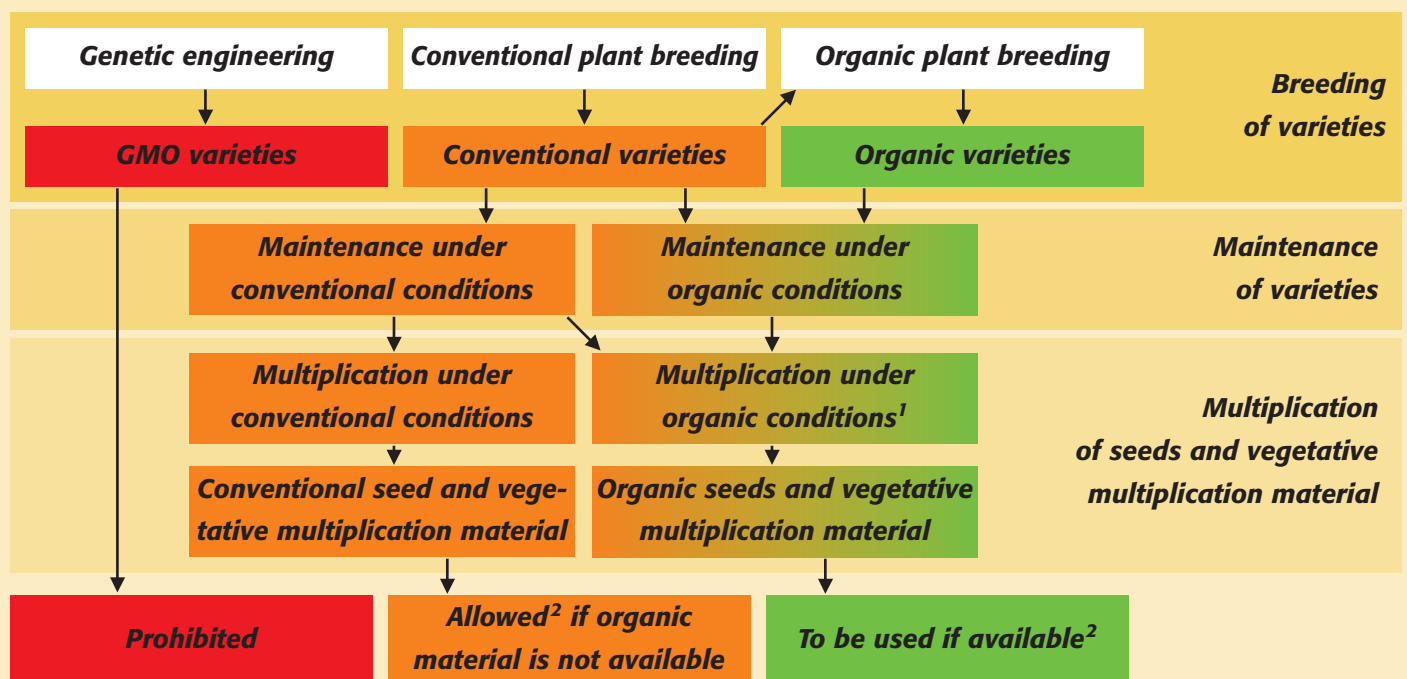

1 Parent plants of annual crops have to be grown at least for one generation under organic conditions, while biannual plants and perennials have to be grown for at least two generations under organic conditions.

2 These are the demands of the EU Regulation 2092/91 until the end of 2003. By 2004 organic producers will have to use only organic seeds and vegetative multiplication material.

# The need for organic plant breeding

Over the last fifty years plant breeding has largely developed in response to the demands of intensive agricultural production, striving for increased yields, storability and cosmetic perfection under a system of management based on artificial fertiliser nutrition and the use of pesticides. Until now, organic farmers have made use of these traditionally bred varieties but the question being asked more and more regularly is «do these varieties truly fulfil the needs of organic production?» Are the seeds and vegetative multiplication material, usually results of traditional and conventional breeding programs, adapted to the conditions of organic agriculture? And, what do consumers expect from an organic variety? Healthy, tasty, and unique products?

Furthermore, the quality of organic products is not simply determined by what they are, but also by taking into account how these crops have been produced. This aspect should also be considered when judging breeding lines for agricultural and horticultural production.

Undoubtedly, the aims of some modern breeding programs and organic breeding programs have certain similarities. However, a number of considerations are particularly important for developing varieties suited to organic conditions:

- optimal adaptation to local climate and nutrient dynamics
- nutrient efficiency
- durable resistance and tolerance against pests and diseases
- yield stability
- storability
- nutritional and sensorical quality

Organic plant breeding aims should be defined on a crop by crop bases involving farmers, breeders, traders, and consumers.

## Plant breeding and multiplication techniques

### *How does plant breeding and multiplication work*

In general, plant breeding can be described as the total of activities to improve the genetic properties of a cultivated crop.

A breeder develops a new variety with one or more specific aims. Therefore, he has to search for parental plants (other varieties or wild relatives) with the desired traits. To obtain plants with the combination of desired characteristics the breeder makes crosses with the parental plants. The result of a cross is a large number of seeds with different genetic make-up (population). In the next plant generations the breeder has to select for individual plants with the best combinations. To facilitate selection he has different techniques available, the choice of which will depend on the crop (self pollinator, cross pollinator, or plant with vegetative multiplication) and the traits he selects for.

In official field trials the usefulness of the new varieties will be compared to existing standard varieties. If the new variety is distinguishable from all other varieties and its appearance is uniform and stable enough over time the breeder will maintain and multiply it for the market.

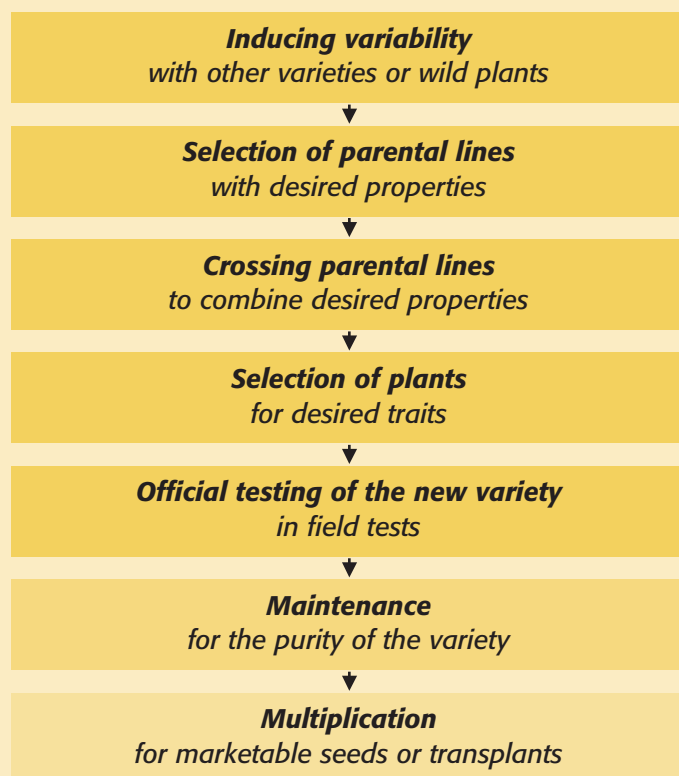

## General distinction of breeding techniques

Plant breeding is characterised by three main steps:

- Induction of variation by creation of crosses or by variation-inducing treatments
- Selection of desired traits in new varieties
- Propagation and multiplication of breeding lines





At each step different techniques can be applied. We can generally distinguish between plant breeding and multiplication techniques which have an impact at:

- plant/population level
- cell/tissue level
- DNA level

Table 1 gives an overview of all techniques and helps with colours and symbols to lead through this booklet. Techniques operating at the plant level are carried out with plants in their «natural» compartment, the soil, while techniques on cell and DNA level are applied under laboratory conditions before the resulting varieties are tested under field conditions. Some cell techniques and especially DNA techniques enable the crossing of natural barriers.

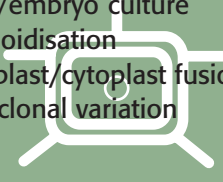
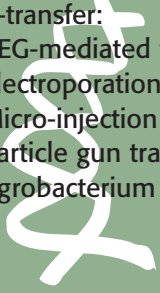
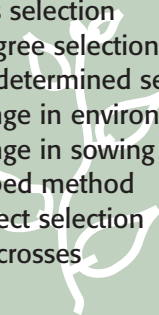
All cell- and tissue culture techniques rely on the capacity of plant cells to grow on synthetic growth media and to differentiate upon stimulation with the appropriate mix of added plant hormones. All plant material needs to be surface sterilized and grown aseptically to avoid contamination with microbes.

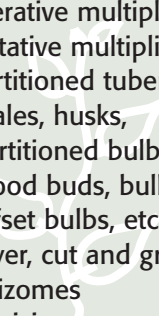
**Table 1: Breeding and multiplication techniques – at which step of the breeding process (inducing variation, selection, multiplication) and at which level (plant, cell, DNA) do they take place.**

	Plant/population level	Cell/tissue level	DNA level
Inducing variation	<ul style="list-style-type: none"> <li>• Combination breeding</li> <li>• Crossing varieties</li> <li>• Bridging crosses</li> <li>• Repeated back-crossing</li> <li>• Temperature treatment</li> <li>• Cutted/grafted style</li> <li>• Mentor pollen technique</li> <li>• F1-Hybrid breeding</li> <li>• Mutation induction</li> </ul>	<ul style="list-style-type: none"> <li>• Anther/microspore culture</li> <li>• «In vitro» pollination</li> <li>• Ovary/embryo culture</li> <li>• Polyploidisation</li> <li>• Protoplast/cytoplast fusion</li> <li>• Somaclonal variation</li> </ul> 	<ul style="list-style-type: none"> <li>• Genetic engineering               <ul style="list-style-type: none"> <li>– DNA-transfer:                   <ul style="list-style-type: none"> <li>– PEG-mediated transfer</li> <li>– Electroporation</li> <li>– Micro-injection</li> <li>– Particle gun transfer</li> <li>– Agrobacterium treatment</li> </ul> </li> </ul> </li> </ul> 
Selection	<ul style="list-style-type: none"> <li>• Mass selection</li> <li>• Pedigree selection</li> <li>• Site determined selection</li> <li>• Change in environment</li> <li>• Change in sowing time</li> <li>• Ear bed method</li> <li>• Indirect selection</li> <li>• Test crosses</li> </ul> 	<ul style="list-style-type: none"> <li>• «In vitro» selection</li> </ul> 	<ul style="list-style-type: none"> <li>• Marker-assisted selection</li> </ul> 
Multiplication	<ul style="list-style-type: none"> <li>• Generative multiplication</li> <li>• Vegetative multiplication               <ul style="list-style-type: none"> <li>– Partitioned tubers</li> <li>– Scales, husks, partitioned bulbs</li> <li>– Brood buds, bulbils</li> <li>– Offset bulbs, etc.</li> <li>– Layer, cut and graft shoots</li> <li>– Rhizomes</li> </ul> </li> <li>• Apomixis</li> </ul> 	<ul style="list-style-type: none"> <li>• «In vitro» multiplication</li> <li>• Meristem culture</li> <li>• Somatic embryogenesis</li> </ul> 	

In the following chapters, breeding techniques will be described starting from methods that are applied on the plant or crop level down to the level of tissue, cells and DNA. The techniques on cell and DNA level are the most controversial for organic plant breeding. These so-called «*in vitro*» techniques have become increasingly common in conventional plant breeding and are the basis of breeding for quite a large number of vegetable, flower, and cereal crops. However, one can argue that these techniques may not be appropriate for organic agriculture as there is no direct contact between the plant and the soil during the process. For each «*in vitro*» technique the «Pros and Cons», «The consequences of rejection», and the «Alternatives» to this technique are given in addition to the «Approach» and «Application». Within «The consequences of rejection» two different levels are distinguished:

- Consequences on variety level: the rejection of a technique prohibits the use of all varieties once bred with this technique.
- Consequences on breeding level: the rejection of a technique makes restrictions on future cultivars and breeding programmes.

The use of genetically modified organisms is prohibited in organic agriculture (EU regulation 2092/91 on organic agriculture). Therefore, no details are given on these techniques within this booklet. DNA diagnostic techniques, which enable selection at DNA level, are not necessarily related to genetic engineering because they do not involve the genetic modification of crop DNA. Therefore, these techniques could be considered for organic plant breeding and are explained within this booklet. In addition, the technique of protoplast fusion, which is related to genetic engineering because it can involve transfer of large pieces of chromosomes from alien species, is also considered.

## ***A simplified story – breeding and multiplication of tomatoes***

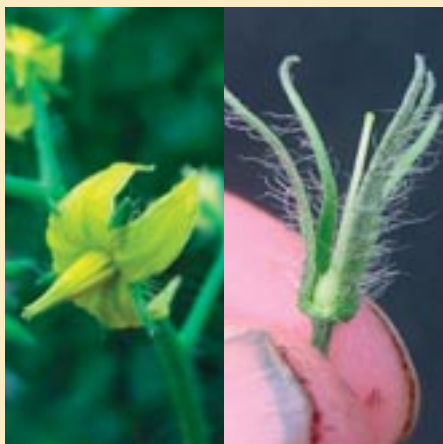

The flower of a selected tomato plant is emasculated ...



... while pollen of an other selected tomato plant is collected.



The pollen is then transferred on to the style for fertilisation. This crossing **induces variation**.



Offsprings are **selected** for different criteria like resistance to diseases, taste, or yield.



After a long period of testing, the new variety is **multiplied** ...



... to get seeds for the market.

## Techniques: approaches, application, alternatives

### Techniques to induce variation at the plant/population level



Crossing of wheat: preparation of the flower (emasculation) ...

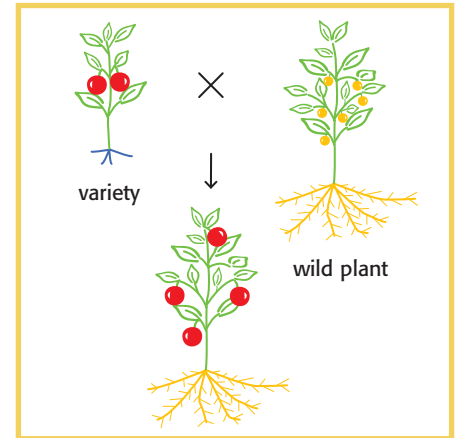
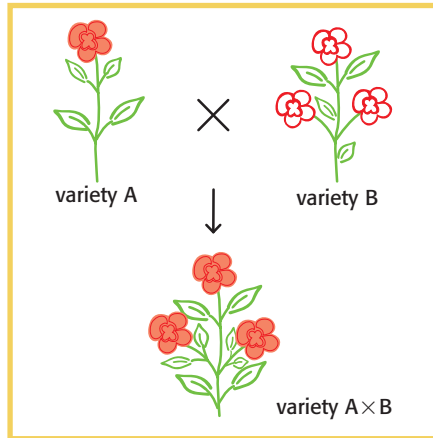

... pollination by hand ...



... and protecting ears with little bags after pollination.

Photos: Gabriela Brändle, FAL

#### Combination breeding



##### Approach:

Crossing two genotypes of the same species, for example two established cultivars. Depending on the plant, whether it is asexually propagating, self-pollinating or cross-pollinating, various generations are propagated and selected after the cross.

##### Application:

Combination breeding is widely used to create variation in breeding lines.

#### Crossing varieties or species



##### Approach:

Crossing of plants with cultivars from other climatic conditions, with wild relatives, or closely related species. Basically, there is a limit to the ability of one plant to fertilise a plant of another species but, breeders have developed a number of methods to get around these cross limitations, for instance treatment of the flower or rescue of embryos. Methods are described later in this booklet which can be carried out in the greenhouse or in the laboratory.

##### Application:

Widely used technique with varying success rates.

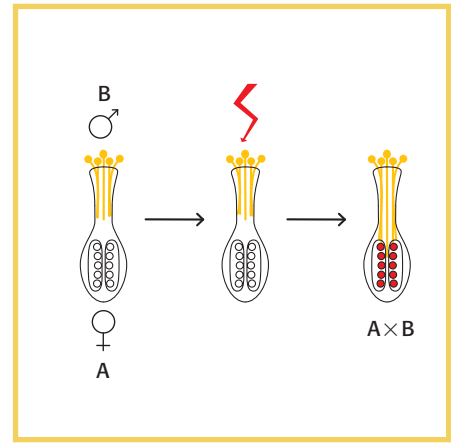
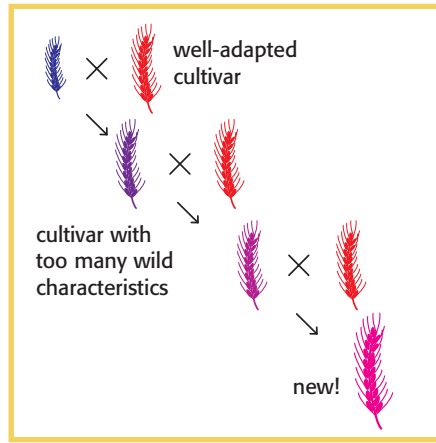
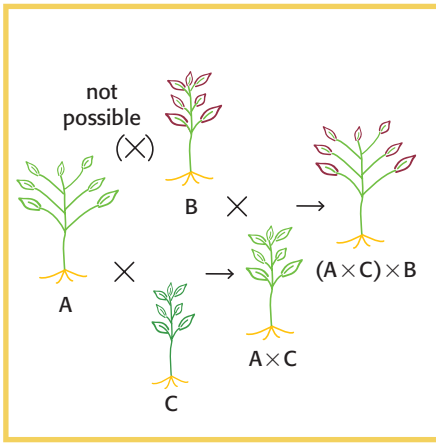

### Bridging cross

#### Approach:

A method of bypassing an incompatibility barrier between two species or genotypes by using a third species or genotype, which is partly compatible with each of them, in an intermediate cross. The wild plant is first crossed with another (wild) species, its progeny is selected for the desired characteristic and these are then crossed with the cultivar.

#### Application:

Used in cases where the desired characteristic is easy to select. Making bridging crosses is a time-consuming process. Once the characteristic has been incorporated in the cultivar, a number of back-crosses are needed to rogue out as many undesirable 'wild characters' as possible.

### Repeated back-crossing

#### Approach:

Species crosses may result in progeny that have too many wild characteristics making direct selection for valuable traits impossible. In these cases, repeated back-crossing with a well-adapted cultivar may eliminate some of the wild and/or exotic traits, finally producing a genotype that is highly similar to the cultivar but with the additional desired characteristic. A breeder must usually make three or four back-crosses before being able to switch to pedigree selection (see page 15).

#### Application:

Repeated back-crossing is always applied when a desirable new trait is incorporated into an existing variety. It has already proven its value for a great number of varieties which have gained a high tolerance to biotic and abiotic stress. Examples are the introduction of race-specific resistance genes against fungal pathogens in lettuce, tomatoes, and many cereals.

### Temperature treatment of the style

#### Approach:

Exposing the plant or the style to higher temperatures for a certain period of time may break down some of the incompatibility barriers in the style. After the temperature treatment, the pollen may succeed in working its way down through the style to the ovary.

#### Application:

Mostly used in ornamental plants (e.g. lilies).



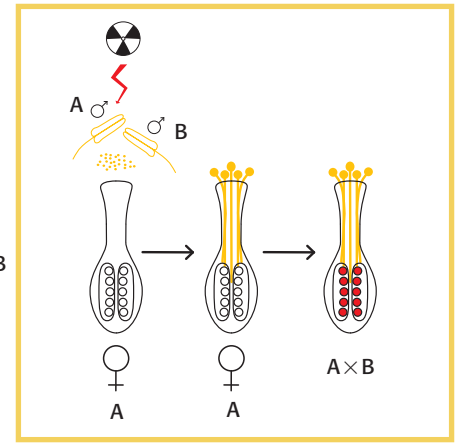
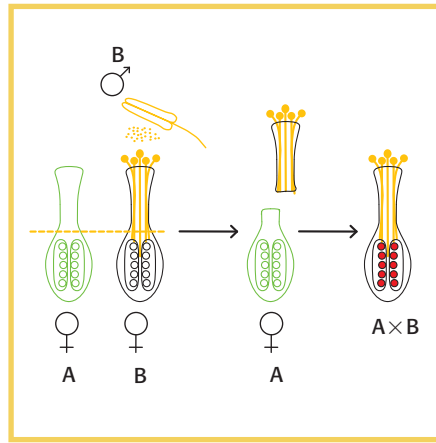
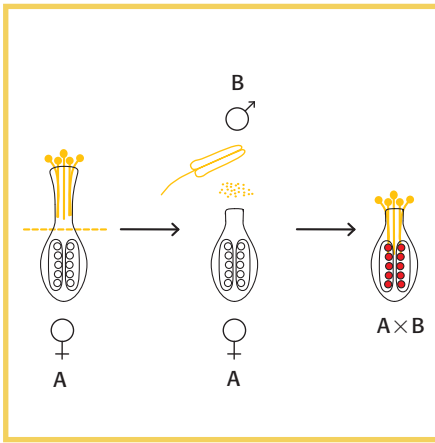

### Cut style



#### Approach:

This method is used when pollen grains germinate on the stigma, but cannot grow far enough into the style, so that the ovary is never fertilised. Sometimes fertilisation can be achieved by cutting (part of) the style of the female plant and applying pollen, mixed with stigma juice, to the surface of the cut. The pollen tube now has only a short distance to grow, increasing the chance of fertilisation.

#### Application:

This method is suitable only for some plants, such as ornamentals with a long style. Seed is only likely to be formed if the two species are closely related.

### Grafting on the style



#### Approach:

This method can be used when pollen fails to germinate on the stigma of the female plant. Pollen is first applied to the stigma of a plant of the same species, so that it germinates effectively and the pollen grows into the style. The style is then cut off, just below the point reached by the pollen germ tubes, and grafted on a cut style of the desired female plant. When the two styles have joined, the pollen germ tubes continue down the style of the female plant and fertilise the ovary.

#### Application:

For practical reasons, the method is only feasible for plants with a fairly long and thick style and is mainly used for ornamental plants such as lilies.

### Mentor pollen technique



#### Approach:

The mentor pollen technique can be used to solve recognition and growth problems. To this end, pollen from the desired male parent is mixed with pollen from the same species as the maternal plant. The latter's pollen has been partially inactivated by irradiation; it still germinates but does not fertilise. The mentor pollen germ tubes 'guide' the pollen germ tubes from the desired male parent to the ovary, which is fertilised by the pollen. Mentor pollen which has not been irradiated, and which has thus retained its vigour, may also be used but is less efficient, because it competes with the pollen of the desired parent.

#### Application:

This technique is mainly used in the breeding of ornamentals.



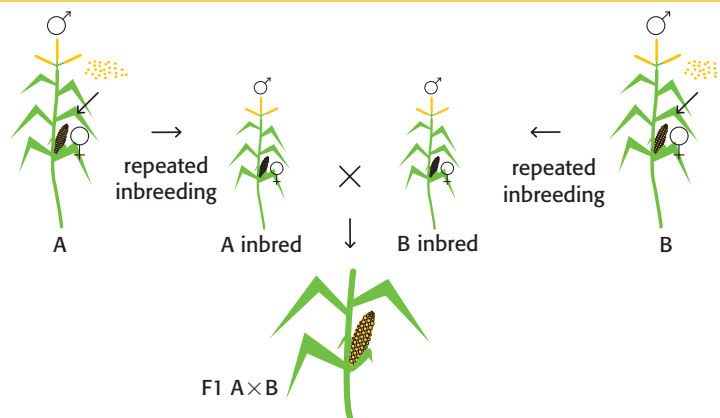

## F1 hybrid breeding



### Approach:

Hybridisation is a way of achieving highly uniform and productive varieties. Parental lines (of cross pollinators) have to be inbred for a number of generations to obtain homozygous lines. The F1 hybrid (the hybrid variety) is the result of a cross between two homozygous inbred lines. These inbred lines sometimes have reduced vigour but, their progeny (F1 hybrids) is highly uniform and vigorous due to heterosis. The F1 hybrid represents the new variety and is sold to the client. Therefore, large numbers of seed need to be produced by fertilisation of the inbred maternal line with the pollen of the inbred paternal line. In plants where male and female inflorescence are physically separated (monoecious), the male inflorescence is removed mechanically (e.g. maize). Other crops are manually emasculated or cytoplasmic male sterility (CMS) is introduced in the maternal line through crossing or protoplast fusion (for details see protoplast fusion). So-called Restorer lines without male sterility, which have the same genetic make-up as the maternal line, are used to maintain the female line. In seed-producing crops, these Restorer genes are also present in paternal lines, so that the resulting F1 hybrid can produce fertile pollen and set seed.

Due to the heterozygous nature of the F1-hybrid seeds, the progeny of these plants will be highly heterogeneous (segregation of favourable traits). It is therefore unlikely that seeds from a F1-hybrid crop will give the same quality and yield as the seeds bought from the breeding company (built-in product protection). Farmers are thus forced to buy new seed every year and this economical aspect is the main reasons why hybrids are so popular with breeders.

### Application:

Widely used technique in many crops (vegetables, maize, rye, sunflower).

### Pros and Cons:

- Pros:
- uniform and productive crops.
  - built-in product protection as an economic guarantee for breeders.
- Cons:
- multiple inbreeding of parental lines can lead to plants which would not survive under organic conditions.
  - no useful seeds can be obtained from hybrids and therefore, farmers are forced to buy new seeds.
  - the nutritional value of hybrids is controversially discussed.

### Consequences of a rejection:

- At variety level: a total rejection of F1 hybrids for all crops would make vegetable crop production difficult for the next 5 to 15 years because many established varieties would have to be replaced. If restrictions are limited to CMS hybrids without Restorer gene, a small number of vegetable varieties (leek, cabbage) would not be available for organic agriculture (see also protoplast fusion).
- At breeding level: time consuming breeding programmes have to be established to get varieties with similar properties and new regulations to protect breeders work have to be established.

### Alternatives:

Quality and yield improvement can be achieved by pedigree and mass selection among open pollinated varieties. If F1 hybrid selection is judged as a technique that is not suitable for organic breeding in the future, all other «traditional» techniques have to be evaluated crop by crop to start special organic breeding programmes.



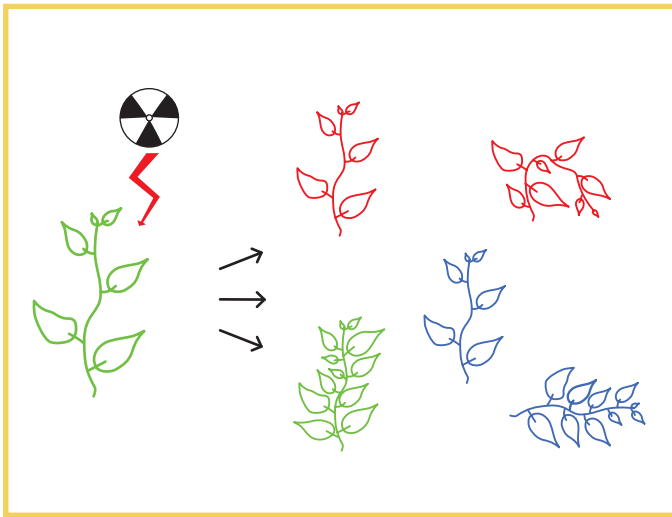

## Techniques to induce variation at the cell/tissue level

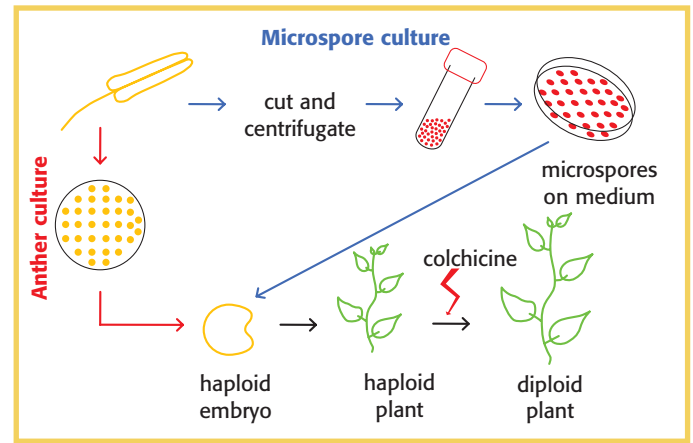

### Mutation induction



#### Approach:

New traits often arise through mutations or changes in DNA. Mutations may occur spontaneously (e.g. by exposure to sunlight, cold or heat, radicals) during cell division or may be provoked by exposing plants to irradiation or chemical agents. Most mutations are recessive and as such are not directly visible in the treated plant. However, after selfing, the mutated genotypes may be identified in the progeny, when two recessive alleles are combined in one plant.

#### Application:

Some examples of genetic variation through induced mutations are flower colour in ornamentals, some sweet cherry varieties, and some dwarfing genes in cereals. Although there is still a large selection of tried and tested mutagens on the market, this technique is not used frequently anymore. This method is often combined with «*in vitro*» selection for resistance against salt, heavy metals, or toxic compounds.

#### Pros and Cons:

Pros: - rapid induction of variation when new traits are needed.  
 Cons: - use of toxic substances or radiation.  
 - can be replaced by less hazardous techniques.

#### Consequences of a rejection:

- At variety level: if varieties which originate from induced mutations were rejected, some varieties in different crops (e.g. sweet cherries and ornamental plants) would be affected. However, it is not clear if the history of these varieties could be traced back.
- At breeding level: not an important loss.

#### Alternatives:

Mutations also occur spontaneously and therefore, natural variation in cultivated and wild plants may be sufficient to obtain the desired traits. However, crossing techniques usually result in a similar level of natural variation.

### Anther and microspore culture



#### Approach:

Immature anthers or pollen grains are cultivated «*in vitro*» to induce pollen grains to develop into multicellular structures, particularly into embryos, with a single set of chromosomes (haploid plants). When such haploid embryos or plants are treated with chromosome doubling agents, e.g. colchicine, their normal chromosome number is restored (and thus their fertility) and the obtained plants are pure (homozygous or inbred) lines. In some cases chromosome doubling occurs spontaneously during «*in vitro*» culture.

Culture of microspores (pollen grain) is actually a further elaboration of anther culture. Rather than using whole anthers, only the microspores are cultured.

#### Application:

Anther and microspore culture is usually carried out at the beginning of a breeding programme. These techniques are applied to obtain homozygous plants in a short time and are commonly used to breed barley, crucifers, and solanum species.

#### Pros and Cons:

Pros: - time and work-saving to get homozygous lines for hybridisation.  
 Cons: - laboratory technique using toxic substances.  
 - generative process is turned into a vegetative process

#### Consequences of a rejection:

- At variety level: some existing varieties of e.g. barley, Brussels sprouts, and pepper would be ruled out. It is not clear if the history of «critical» varieties can be traced back.
- At breeding level: the more time-consuming inbreeding must be used to get homozygous lines.

#### Alternatives:

These techniques aim to simplify the process of selection and to accelerate the process to get homozygous lines for making F1 hybrids. However, no new characteristics are added to the plant. From a genetic point of view, plants obtained through the culture of anthers or microspores are identical to inbred lines. Therefore, with more time and work almost the same results could be achieved by traditional breeding.

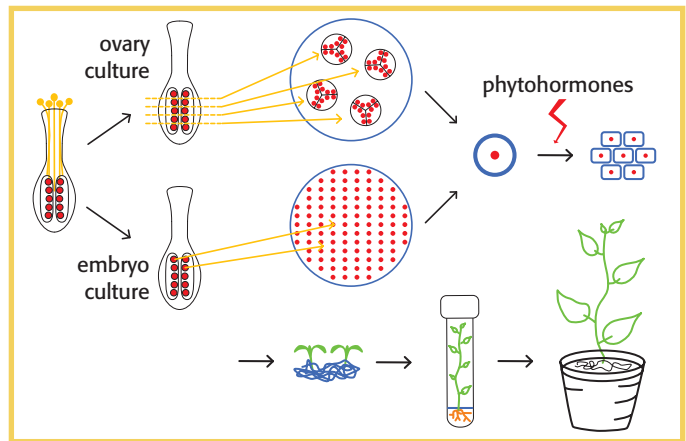
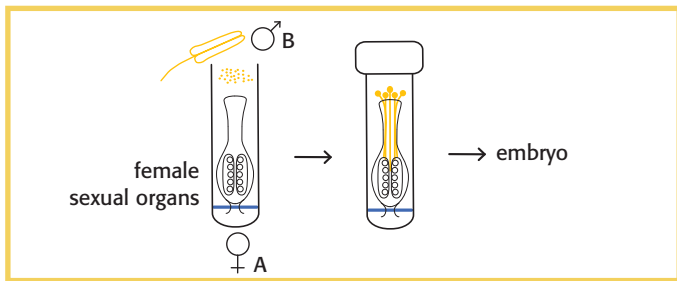

## «In vitro» pollination



### Approach:

In crosses, for example between a cultivar and its wild relative, fertilisation sometimes fails, either because the pollen won't germinate or because it can't get to the ovary. Sometimes pollination and fertilisation can be achieved *in vitro*. Ovaries or ovules are removed from the plants under sterile laboratory conditions and fertilised *in vitro* with pollen. Fertilisation barriers between the stigma and the ovary can thus be overcome.

The cut style and grafted style methods (see «cut style» and «grafting on the style») are also used *in vitro*. However, rather than being carried out on the whole plant they are carried out on isolated ovules cultured in a test tube or petri dish.

### Application:

The technique is usually applied at the beginning of a breeding programme which is aimed specifically at introducing a certain character, for example a resistance gene from a (wild) closely related species, into a cultivar. More genetic combinations can be made than was previously possible. However, the method has a low success rate, although this depends strongly on the species used and the combinations made. It is mostly used for ornamental breeding.

### Pros and Cons:

Pros: - improve the chances of overcoming natural barriers of crossing that could rarely occur in nature.  
Cons: - forced crossing of natural barriers in artificial and sterile conditions.

### Consequences of a rejection:

- At variety level: some varieties of ornamentals would have to be ruled out. It is not clear if the history of «critical» varieties can be traced back.
- At breeding level: a rejection of this technique would be a minor restriction because there are alternative techniques.

### Alternatives:

The techniques «cut style» and «grafting on the style» could replace the *in vitro* pollination.

## Ovary and embryo culture



### Approach:

Despite successful fertilisation, an embryo may not develop into a mature seed. The purpose of ovary and embryo culture is to transfer the embryo to an artificial nutritional substrate at an early stage, so that it need no longer depend on plant resources.

In ovary culture, the entire ovary or slices of the ovary are placed on the substrate. The ovules swell and at a certain point are removed from the ovaries and cultured independently. By this time, the ovules have in fact become seeds on a substrate, where they may germinate.

In embryo culture, embryos are isolated from fertilised flower buds and placed on a nutritive substrate to germinate.

### Application:

Embryo culture (and ovary culture) is the most frequently used technique to cross in resistance genes from (wild) closely related species. These techniques were often used for tomatoes, sweet pepper, courgettes, lettuce, wheat, and a lot of other crops. 80 to 100% of the cultivars originate from one or the other inter-species cross. More combinations can be achieved than with standard crosses, since the first steps of embryogenesis have been made on the plant and development is completed by growing the embryo on substrate.

### Pros and Cons:

Pros: - improve the chances of overcoming natural barriers of crossing that could rarely occur in nature.  
Cons: - forced development of embryos under artificial and sterile conditions using synthetic phytohormones.

### Consequences of a rejection:

- At variety level: most modern varieties of tomatoes and many sweet pepper, lettuce, cereal and courgette varieties were bred using this type of technique and would be ruled out for organic agriculture.
- At breeding level: very time-consuming alternatives.

### Alternatives:

Instead of embryo culture much more crossings would have to be carried out. Instead of 50 crosses, more than 1000 would need to be done to get a few viable seeds. Alternatively, different parents should be selected from stocks or the wild accessions.



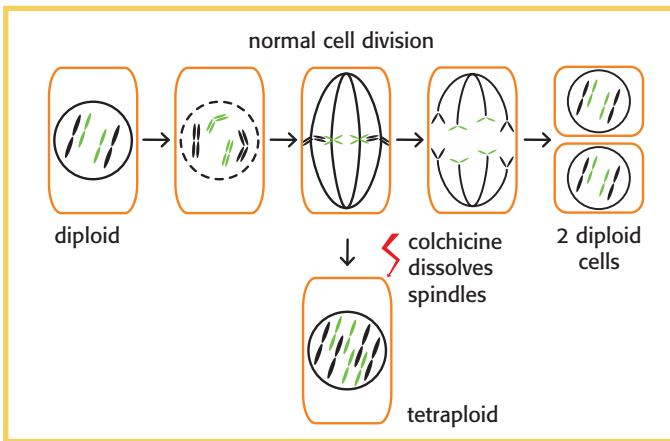

## Polyplodisation



### Approach:

A plant cell typically has two copies of each chromosome (diploid). A cell is polyploid if it has at least twice the normal number of chromosomes (tetraploid). Polyploidy can occur spontaneously or can be induced using chemicals such as colchicine. Normally, during cell division the spindle in the cell ensures that each half of the set of chromosomes is reorganised into two new cells. Colchicine dissolves the spindle, so that the chromosomes remain in one cell and then duplicate (tetraploid cell). When small meristems or seed are treated with colchicine, they are likely to grow into a plant with a completely doubled genome.

### Application:

Doubling the number of chromosomes is sometimes necessary to restore the fertility of plants obtained through species crosses or haploidisation. However, polyploidisation is also applied to get plants with a double set of chromosomes (potatoes, clover, forrage grasses, ornamentals). These plants are generally larger or more robust than plants with the normal number of chromosomes. They may therefore be more profitable or have a higher ornamental value.

### Pros and Cons:

Pros: - easy way to restore fertility of plants and to get larger and more robust varieties.

Cons: - use of a toxic substance (colchicine).

### Consequences of a rejection:

- At variety level: since it is difficult to trace back the origin of the genome duplication, either spontaneous or chemically-induced, it is difficult to judge polyploid varieties. However, for some crops it is known that colchicine was used to develop parent lines (e.g. potatoes with Pallida resistance or tetraploid grasses).
- At breeding level: without polyploidisation it will be difficult to restore fertility of some plant species.

### Alternatives:

If necessary spontaneous polyploids can be selected for the desired crop or ornamental.

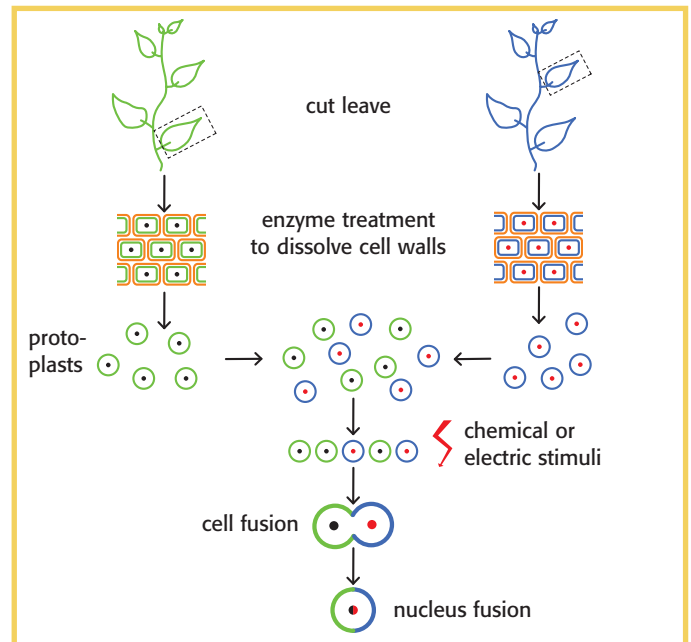

## Protoplast/Cytoplasm fusion



### Approach:

Protoplasts are cells without a cell wall. These are obtained by treating fragments of leaves with cell wall dissolving enzymes. The protoplasts then grow a cell wall again and divide, resulting in a callus from which plants can regenerate. Protoplasts of different plant species can be fused with chemical or electric stimuli (somatic hybridisation). During this fusion, the organelles of both plants (chloroplasts and mitochondria) are combined, while in crosses, only maternal chloroplasts and mitochondria are passed on to the progeny. The resulting tetraploid fusion product has the characteristics of both parent species. During regeneration the chromosomes and the organelles of both parents may be mixed, so that many combinations are produced. To avoid exchange of chromosomes, protoplasts can be treated in such a way that the nucleus is removed or fragmented. These so-called cytoplasts do contain the organelles, but not the chromosomes of the donor plant. In this way CMS (cytoplasmic male sterility) can be transferred to other plant species. Breeding companies use different plant sources of CMS and have patents on the application of these kinds of CMS by describing the associated DNA changes in mitochondrial genome.

### Application:

In combining the maternal and paternal organelles, new combinations are made. An example is male sterility, which is determined by organelles (mitochondria). This method was used to transfer natural cytoplasmic male sterility (CMS) of radish CMS to cabbage and of sunflower CMS to chicory. After fusion, selection is directed at the cytoplasmic characteristic. The protoplast method is used to insert complete chromosome fragments from an other less related species into a cultivar.

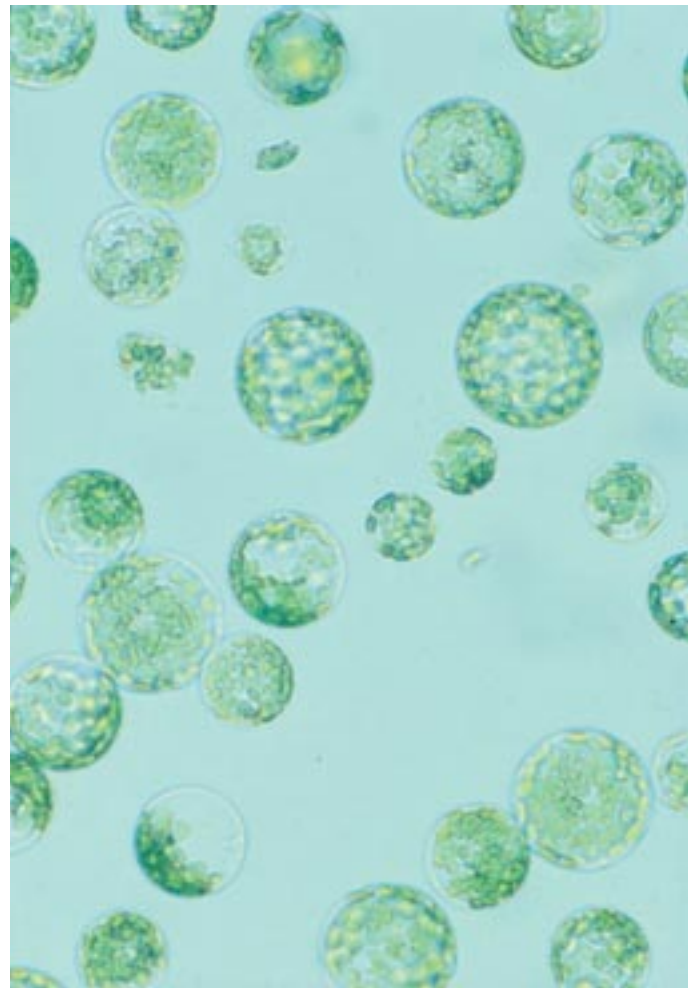
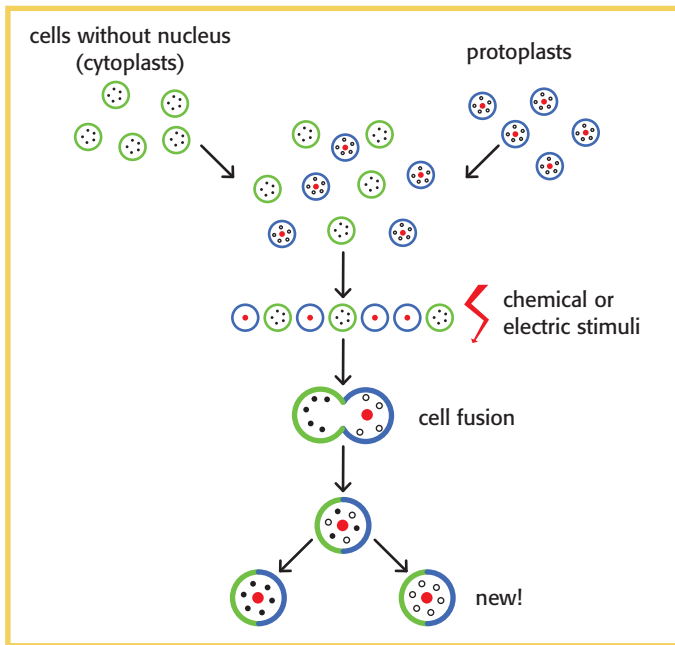

Photos: Michel Haring, University of Amsterdam

**Pros and Cons:**

- Pros: - rapid way to get new combinations and traits which would not be possible in nature.  
 Cons: - natural barriers are forced with this method which is closely related to genetic engineering.

**Consequences of a rejection:**

- At variety level: only a few modern cabbage, endive, leek, and chicory varieties would be ruled out for organic agriculture if this technique was forbidden for organic plant breeding.
- At breeding level: protoplast fusion is not of great importance, yet. Goals of organic plant breeding can be achieved without it. Cytoplasm fusion is of great importance to induce CMS.

**Alternatives:**

A hybrid breeding program for cabbage could also be based on the self-incompatibility (hinders self-fertilisation) of some cabbage species.

Protoplasts of tobacco.

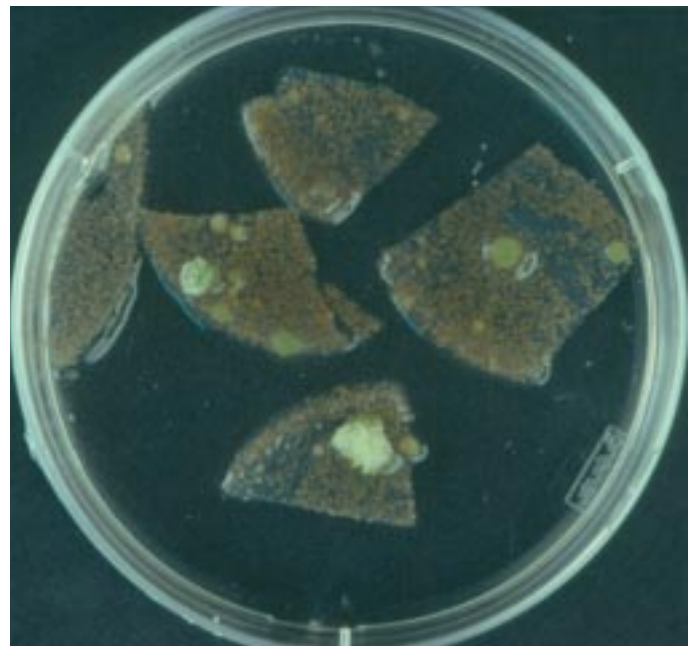

After fusion protoplasts are regenerated (green cultures).



## Techniques for selection at the plant/population level

Photo: Louis Bolck Institute



Mass selection: salads are selected for different criteria (e.g. disease resistance) on test plots in the field.

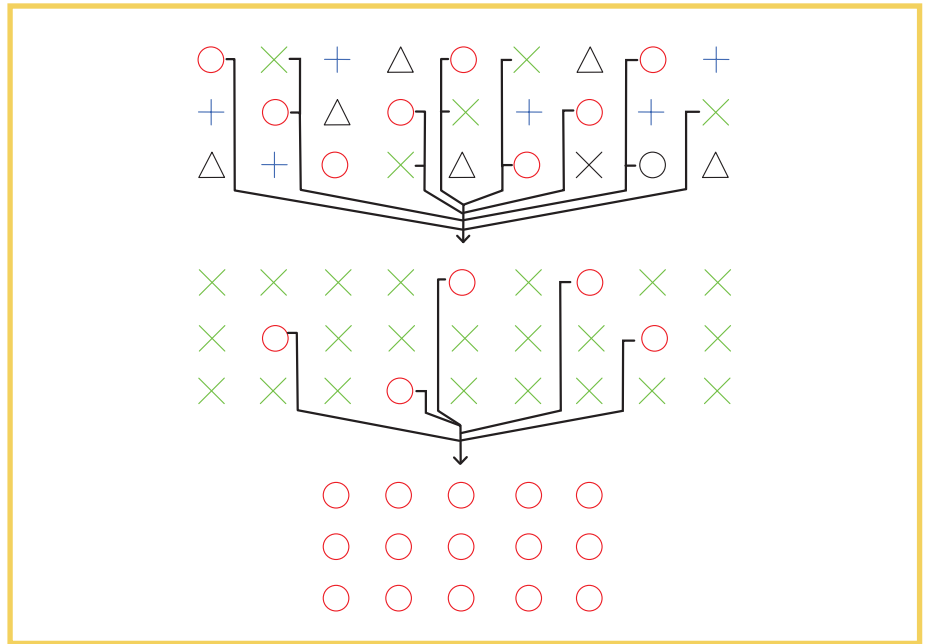
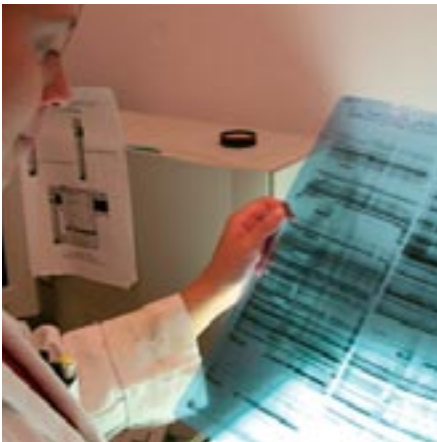

Photo: Michel Haring



Marker-assisted selection: evaluation of an autoradiogram of a gel with DNA markers (see page 18).

### Mass selection



#### Approach:

Mass selection is based on the ability to recognise desirable or undesirable traits in plants of a population. What appear to be the best plants are maintained in bulk (positive mass selection), while plants with too little of the desired characteristic are eliminated (negative mass selection). Since selection is based on phenotype, the technique is particularly effective for traits which are barely influenced by environmental factors and which are not inherited as dominant or recessive traits but rather as complex traits.

#### Application:

The technique is mostly applied during the early stages of a breeding programme, when there is not enough representative plant- or seedstock for repeated testing, when seedstock needs to be improved, or when little capital is available for a breeding programme. However, breeding based only on mass selection is a lengthy process. This is the selection method that most resembles natural selection.

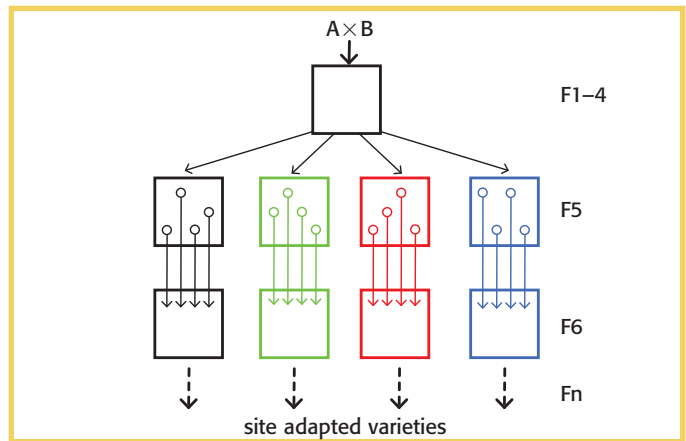
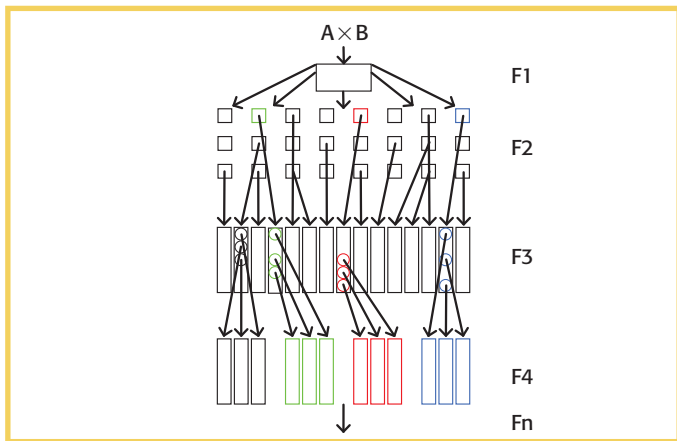

## Pedigree selection



### Approach:

In pedigree selection, elite plant lines are developed from a single plant. Each selected plant is harvested separately and grown as distinct lines in the following year. Lines will only be maintained following a favourable assessment of performance throughout the line. The best plants of the line will be identified and their seed will again be harvested separately for the next round. The selection is made on the basis of general impressions (phenotype) and heredity of the desired characteristics (genotype).

### Application:

The pedigree method involves visual selection among individual plants in early generations. Because the pedigree method uses selection in each generation, each generation must be grown in an environment where genetic differences will be expressed (greenhouses and off-season nurseries may not be useful). Pedigree selection produces new cultivars faster than mass selection. The method is particularly appropriate for self-pollinators.

## Site-determined selection



### Approach:

The goal of this selection method is to select varieties, sometimes population varieties, which are optimally adapted to specific regional conditions. The parent lines are also selected with the final growing site (region) of the crop in mind. Crosses are carried out at a central location, where the F1 and early generations (F2 to F4) are also sown. The F5 to Fn plants are assessed and selected at different locations by means of pedigree selection. This is a combination of natural selection and artificial selection. In other words, environmental factors determine which characteristics are expressed and which are not and this may influence the breeder's selection of promising phenotypes.

### Application:

This method is applied especially in «organic» breeding programmes for cereals such as wheat, barley, rye and spelt. However, in theory it is also suitable for use with other crops.



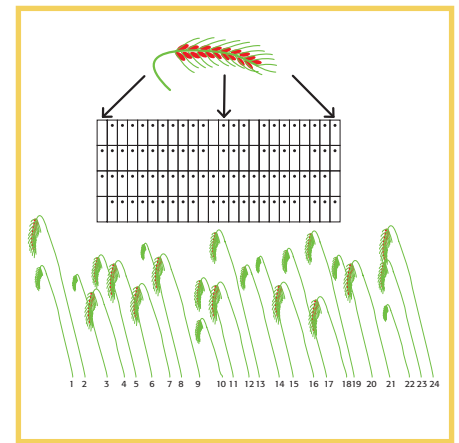
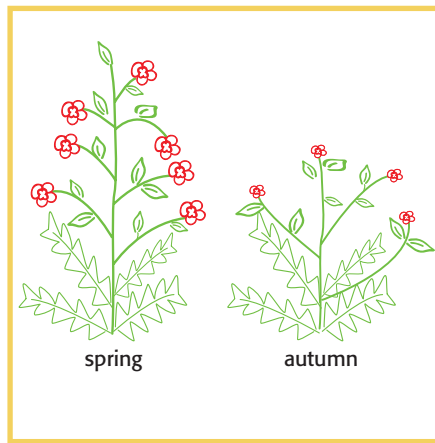
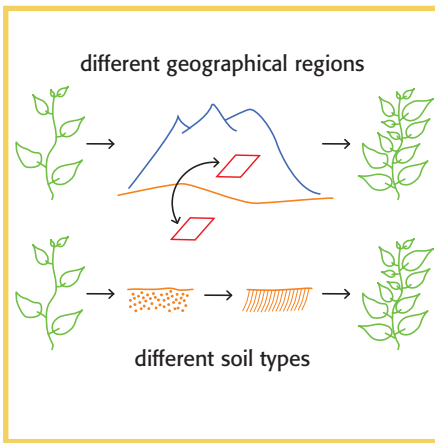

**Change in environment** 

**Approach:**  
Change of environment during the selection process is also called shuttle breeding. This method is used to select broadly adapted genotypes out of segregating populations.

**Application:**  
This method can be used for self- and cross-pollinating crops.  
Some bio-dynamic breeders also use this technique to induce variation and even to enhance the vigour of a variety.

**Change in sowing time** 

**Approach:**  
A change in the sowing time (early and late spring; early or late autumn) is usually applied to select for day-length insensitivity, reduced vernalisation requirement, and yield and quality stability in different length of growth period.

**Application:**  
This method can be used in self- and cross-pollinating crops.  
Some bio-dynamic breeders consider this method to improve seed quality. It is especially used in cereals.

**Ear-bed method** 

**Approach:**  
An ear-bed is a seedbed in which the grains from one ear are sown in the same sequence in which they were arranged in the ear. Thus the plants in the seedbed (ear-bed) reflect the quality of the original ear.

**Application:**  
This breeding method was developed by bio-dynamic plant breeders especially for cereals, but it may also be used for other crops.



## Techniques for selection at the cell/tissue level

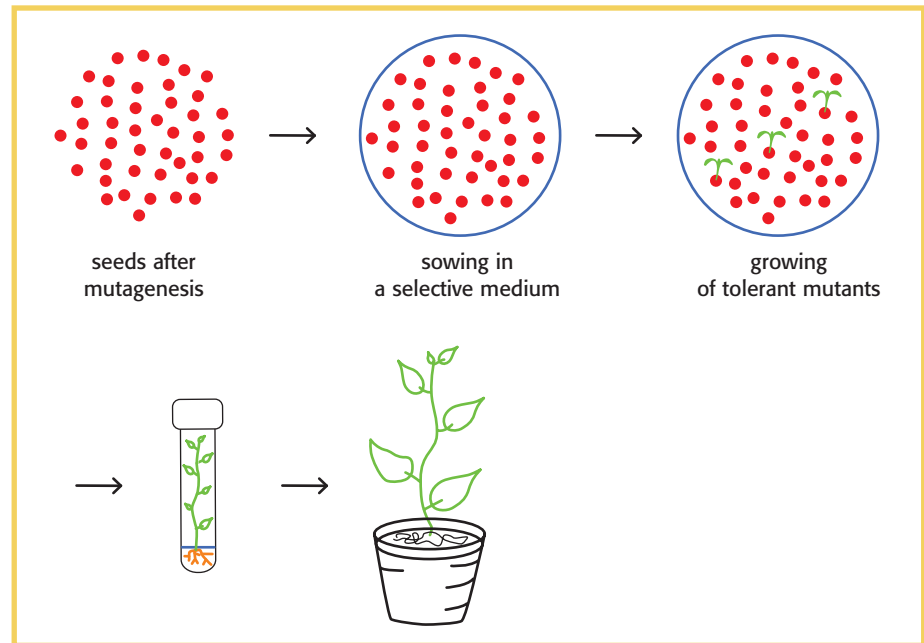
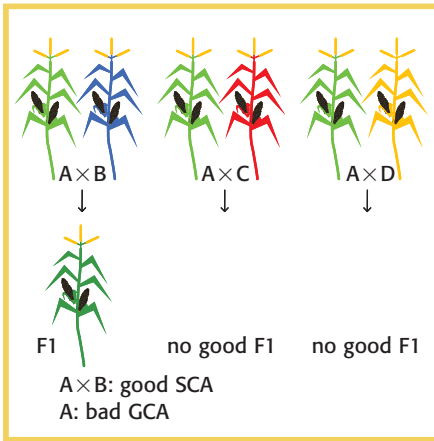

### Test crosses



#### Approach:

Promising parental genotypes are crossed with a number of other known genotypes. Progeny is grown separately and assessed for the desired characteristics. The measurements are used to determine General Combining Ability (GCA) and Specific Combining Ability (SCA), and these are needed if effective crosses are to be made.

#### Application:

In breeding, it is not enough merely to select the best cultivars, but parents with good crossing ability must also be available, so that a number of important characteristics are combined and passed on to progeny. This is especially crucial for asexually propagated plants and hybrids. Test crosses are asking extensive testing facilities and are time consuming. However, they are an investment in the future.

### «In vitro» selection



#### Approach:

«In vitro» selection uses somaclonal variation or mutation induction to select plants with new traits. For example, to obtain plants with a high tolerance to salt, selection occurs in a saline environment. This can be done by treatment of individual plant cells that are growing in tissue culture or by treatment of seeds and subsequent germination on selective growth medium. Selection for resistance to diseases and pests can also be carried out «in vitro». The pathogen, or a toxin produced by the pathogen, is applied to the plants under controlled conditions.

#### Application:

This technique is used to screen many plants or cells for one specific characteristic. It is a sort of pre-selection to reduce the number of plants to be tested in the field. After «in vitro» selection plants are always tested under field circumstances to observe the expression of the characteristics in the open field. Plants resulting from this selection process may be marketed directly as a new variety (after «in vitro» multiplication) or they may be used as a parent in further breeding programmes.

#### Pros and Cons:

Pros: - cheap way to pre-select plants and reduce the number of plants to be tested in the field.

Cons: - the artificial and sterile conditions in the laboratory do not help to select for organic conditions.

#### Consequences of a rejection:

- At variety level: some varieties of different crops would be ruled out for organic agriculture if this technique were to be prohibited in organic breeding. «In vitro» selection can not be identified in the product and can therefore not be controlled.
- At breeding level: more time-consuming selections in the field would be needed.

#### Alternatives:

Similar selection for specific characters could be done with the above mentioned techniques of selection in the field, but they are much more time consuming. On the other hand, selection in the field helps to find plants adapted to a broader range of environmental factors.



## Techniques for selection at the DNA level

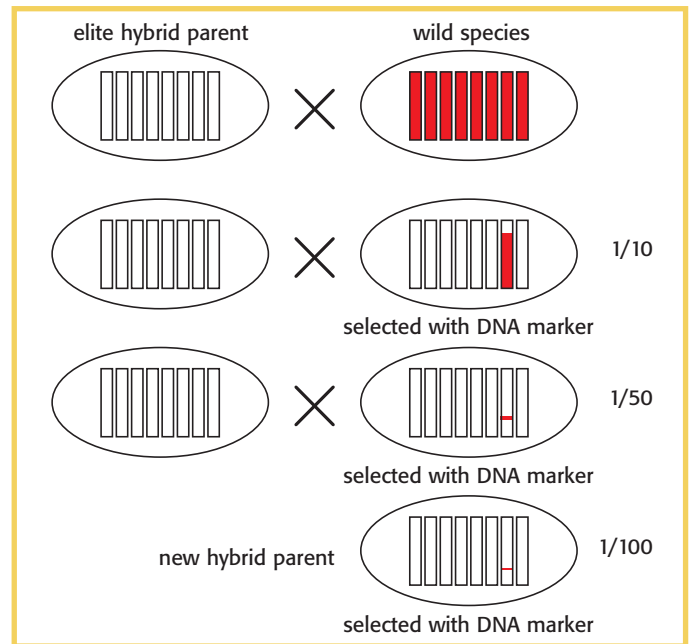
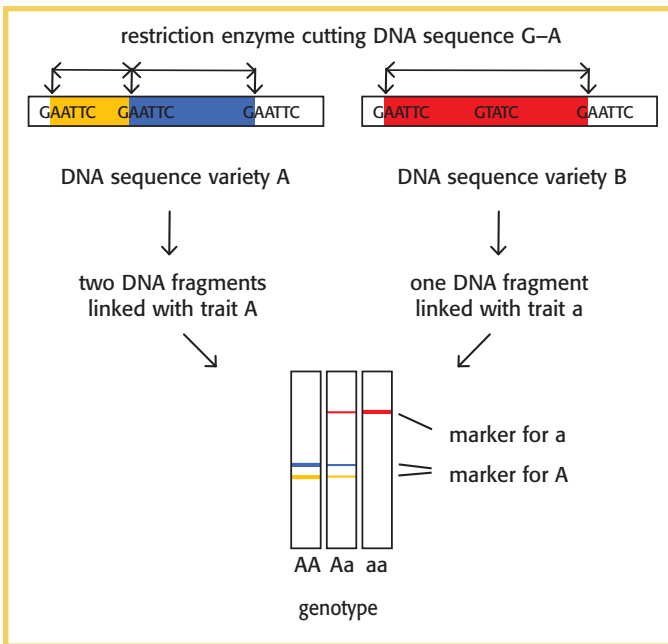

### Marker-assisted selection

#### Approach:

Biochemical and molecular techniques are often used in direct selection. Polymorphism of plants is fixed at different levels: the molecular, biochemical, and phenotypic level. On biochemical level some plant proteins (enzymes) can have a slightly different composition in different plant varieties and can be visualised as different banding patterns (isozymes). By genetic analysis a certain band can be linked to a desirable trait (yield, taste, resistance). When this linkage is established, the presence of the marker (isozyme band) in a breeding line suggests that the linked trait is also present.

Similarly, the variation in the DNA sequence around a gene or genes determining a desired trait can be revealed by isolating the DNA and making parts of the DNA base sequence visible. Visualisation techniques all require a treatment of DNA with restriction enzymes and radio-active or fluorescent labels. These enzymes are naturally occurring in bacteria and can be isolated from them. Today, they are usually produced as recombinant proteins. These are indistinguishable from non-recombinant enzymes and can be isolated at a fraction of the costs. The resulting banding pattern of the different DNA fragments is used to find those bands which are linked to the desired characteristic of a plant. This tool does not rely on the introduction of transgenic DNA into the plant, but analyses the DNA content of individual progeny to preselect for the presence of known traits.

#### Application:

Molecular markers can be used for a particular DNA segment which is linked to a trait of interest. Traits can be caused by single gene or be due to a number of genes. The aim of marker-assisted breeding is to speed up selection and to directly select for traits. In the future, large populations could first be screened for the presence of known markers (i.e. traits), before being used in field plots. A prerequisite for marker-assisted

selection is that a marker is found that is closely linked to a desired characteristic. It requires an extensive genetic mapping programme before this technique can be used in a breeding programme. The molecular markers that are developed by breeding companies are often patented to prevent the competition from developing the same traits. This technique is increasingly used in breeding programmes for all crops.

#### Pros and Cons:

- Pros: - efficient and less time consuming selection.  
- allows the pyramidisation of resistance genes for better resistance.
- Cons: - reduces the plant to a subset of DNA sequences  
- use of toxic substances.

#### Consequences of a rejection:

- At variety level: at the moment, modern plant breeding uses this tool for selection with the goal to improve breeding in terms of time and costs. However, only a few varieties selected with this technique are on the market.
- At breeding level: the application of marker-based selection cannot be identified in the product and can therefore not be controlled.

#### Alternatives:

As soon as markers for important characteristics are found, this tool will help to make selection more efficient and less time consuming. However, most techniques of selection can replace marker-based selection, provided that there are no financial and infrastructural restraints.

## Techniques for multiplication at the plant/population level

Photo: Markus Kellerhals, FAW



Multiplication of apple seedlings.

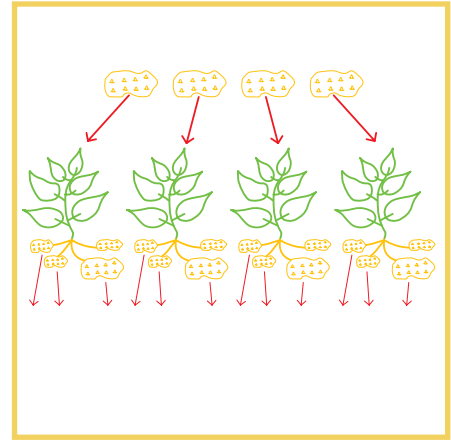
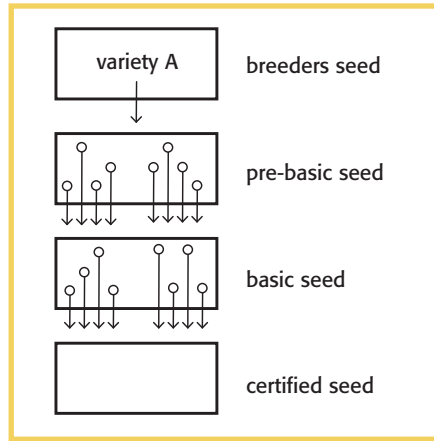

### Multiplication of sexually reproducing plants



#### Approach:

When a new variety has been selected out of the new genetic variation, it must be propagated and maintained as a pure bred. In self-pollinating and cross-pollinating plants, the selected genotypes flower in isolation. Positive mass selection ensures that the elite parent lines are of high quality and meet all the requirements of a variety. Not all diseases in parent plants are passed on to seed, but some seedborne diseases like *Alternaria* on carrots and Common bunt on wheat need special attention. Most seed can be stored for long periods of time.

#### Application:

Used for all sexually reproducing plants.

### Multiplication of asexually reproducing plants



#### Approach:

In asexually propagated plants, such as beets, potatoes, bulbs or grafted plants, extra care must be taken to avoid deterioration in the health of the seed or plant stock. Living plant stock often does not keep well, thus these lines are maintained through a continuous process of multiplication. However, the advantage of vegetative multiplication is that the progeny has exactly the same genotype as the parent, whether heterozygous or homozygous.

#### Application:

Used for all asexually reproducing plants.



«In vitro» multiplication of sugar beets.

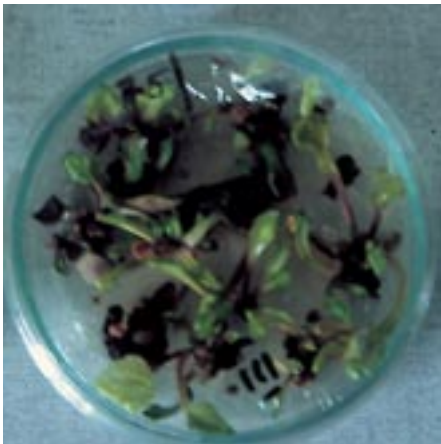

Meristem culture of sugar beet in petridishes.

Photos: Gumilla Lissek-Wolf



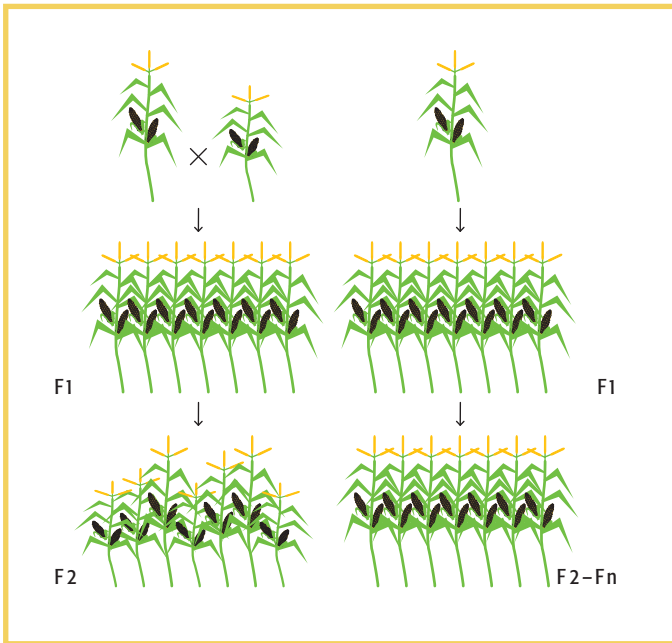

## Techniques for multiplication at the cell/tissue level

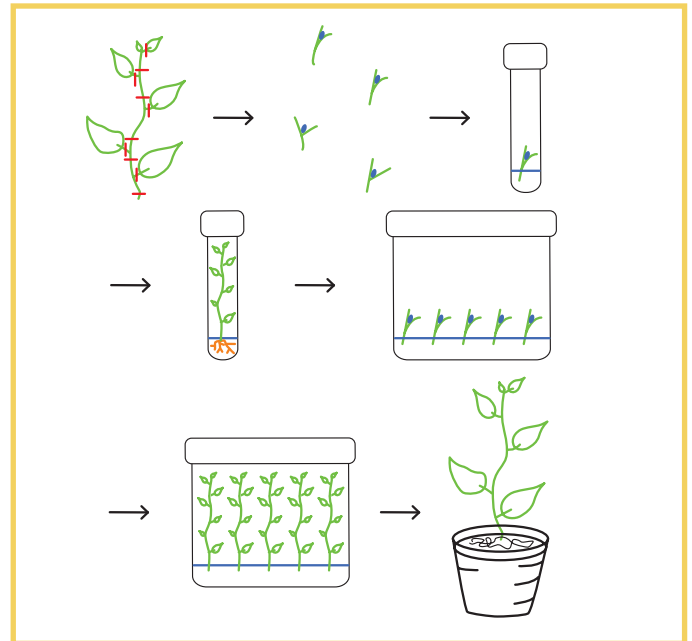

### Apomixis

#### Approach:

Some species can reproduce asexually through seeds. This phenomenon is called apomixis. In the seed forming process, meiosis that is essential for sexual reproduction, is either suppressed or circumvented so that the embryo is genetically identical to the mother plant. There are obligate apomicts, whose seed contains apomictic embryos, and facultative apomicts, which can form both sexual and apomictic embryos in their seeds.

#### Application:

Apomixis occurs in cultivated plants (*Poa pratensis*, oranges, tropical plants) and wild plants and has caught breeders' interest because it combines the advantages of seed multiplication - health and maintenance of quality - with the identical reproduction of the maternal genotype. Apomictic multiplication is considered a promising method to maintain varieties and to fix the heterosis effect of hybrids. The technique is hardly used in today's plant breeding but, with the help of genetic engineering the technique is expected to become available for a large number of crop species in the near future.

### «In vitro» multiplication

#### Approach:

Depending on the plant species, some part of a plant - most commonly a piece of stem with an axillary bud, or part of a leaf or bulb scale - is cultured «*in vitro*». These sections of plant grow out to form shoots, which can in turn be cut and propagated. This may be repeated several times to get enough plants. These are grown until their roots are developed, then hardened off and transferred to normal greenhouse and/or field conditions.

#### Application:

This method is often used to get enough basic material to be able to bring a new variety on the market. In addition, this technique is being used more regularly to maintain parent lines of hybrids.

#### Pros and Cons:

Pros: -cheap and rapid way to multiply great numbers of plants.

Cons: -the sterile and artificial conditions could lead to a selection for laboratory conditions.

#### Consequences of a rejection:

- At variety level: some varieties of cut flowers and leek hybrids would be ruled out.
- At multiplication level: more expensive and time-consuming techniques have to be applied.

#### Alternatives:

For most crops there are other multiplication methods which are quite effective.

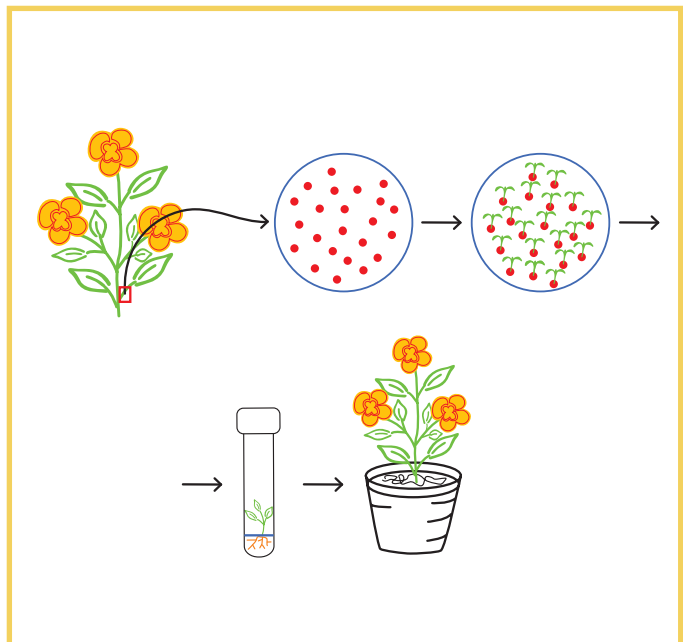
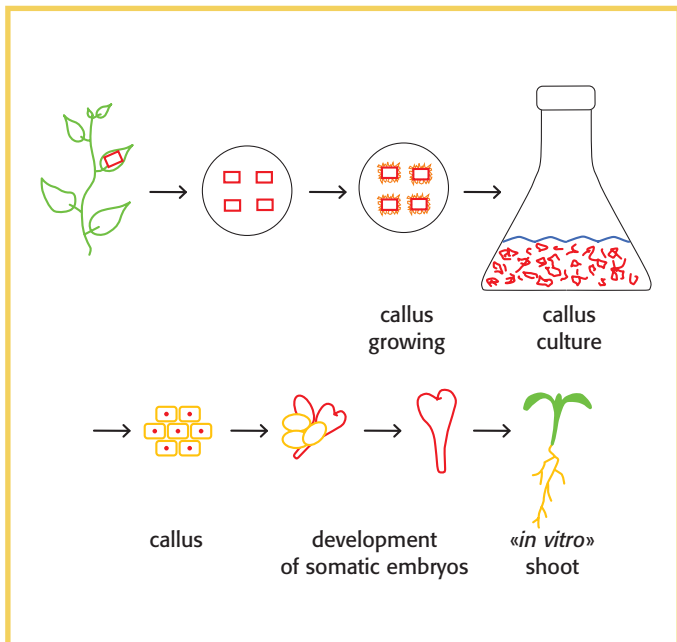

## Somatic embryogenesis



### Approach:

Somatic embryos are created from a piece of plant material isolated from the mother plant and may or may not first have undergone a callus phase. Callus, which is commonly propagated in liquid medium, is homogenised to form a cell suspension. Plant hormones are added to the cells isolated from the mother plant, the callus or the cell suspension to stimulate the cells' development into somatic embryos. Often, these embryos are in turn capable of forming secondary embryos, thus leading to a continuous multiplication process. From these embryos a new plant can be regenerated «*in vitro*».

### Application:

This method has the greatest multiplication potential and is less labour intensive compared to other «*in vitro*» multiplication methods. The method can be used for large-scale or even automated production.

### Pros and Cons:

- Pros: -very cheap and rapid way to multiply great numbers of plants.
- Cons: -the sterile and artificial conditions could lead to a selection for laboratory conditions.  
 - use of synthetic phytohormones.  
 - risk of spontaneous mutations.

### Consequences of a rejection:

- At variety level: many varieties of cut flowers would be ruled out.
- At multiplication level: more expensive and time-consuming techniques have to be applied.

### Alternatives:

For most crops there are other multiplication methods which are quite effective.

## Meristem culture



### Approach:

In meristem culture, parts from the meristem are isolated and cultured on substrate. The resulting plants are screened for viruses with the ELISA method. Uninfected plants are then propagated in the manner described previously.

### Application:

Meristem culture often is the only way to get virus-free plant material (e.g. berries, bulbs, potatoes). Viruses can be especially persistent in asexually propagated plants, because they are passed on to the following year's stock (e.g. garlic). Viruses proliferate and spread through the plant, but they never quite catch up with the rapidly dividing cells in the plant meristem. This method is widely used for multiplication of fruit rootstock, transplants of berries, flower bulbs, and vegetables.

### Pros and Cons:

- Pros: -best and often only way to get virus-free plants.
- Cons: - use of synthetic phytohormones.

### Consequences of a rejection:

- At variety level: most rootstocks of fruits and transplants of berries and many vegetable varieties would be ruled out.
- At multiplication level: new techniques would have to be developed.

### Alternatives:

If just the youngest parts of plants are used for multiplication, virus-free multiplication should also be possible using standard multiplication methods.



# Judging the suitability of the breeding and multiplication techniques for organic agriculture

If guidelines and guide-posts are to be developed for organic plant breeding then the suitability of breeding and multiplication techniques must be evaluated. Discussion on national and international level showed that in order to do this, criteria for evaluation must be set (Wiethaler et al., 2000). Criteria could be derived from the basic principles of organic agriculture and translated to plant breeding. The Louis Bolk Institute has worked out a suggestion for such criteria (Lammerts van Bueren et al., 1999). The authors of this suggestion used three basic principles in organic agriculture as a starting point:

- closed production cycles
- natural self regulation
- biodiversity

In order to draw up a framework for an organic breeding system these principles could be extrapolated to the level of plants. The three criteria for organic plant breeding then are:

- natural reproductive ability of plants
- ability to adapt to organic conditions
- genetic diversity with respect for natural species authenticity and species characteristics.

As breeding is also a socio-economic activity these principles could also be applied to the socio-economic level:

- close interaction between farmers, breeders, traders, and consumers for a participative plant breeding
- regulations incorporating organic principles
- cultural diversity: diverse breeding programmes as a prerequisite for genetic diversity. This includes free exchange of varieties among breeders. Therefore, plants should be maintained with an ability to pass on genes to future breeding programmes. This includes production of fertile seeds and the prevention of patenting varieties.

On the basis of these principles, plant and crop based breeding techniques best suit an interactive organic breeding system. These principles would lead to breeding techniques allowing the whole breeding process to take place under organic (soil) conditions. This creates an ethical dilemma. Does that imply that

the smallest living entity to work with in organic breeding programmes is the plant or the crop? Or, is the plant cell the smallest living entity because it can regenerate into a plant again or do we want to reduce life to the complexity of heritable material, the DNA? Table 2 considers the suitability of breeding and multiplication techniques for organic plant breeding based on three ethical interpretations of the smallest living entity – the plant, the cell, or the DNA.

The result of judging the techniques from these different points of view would have quite different consequences for the actual seed availability of the most important crop groups:

- plants as the smallest living entity: some few cereal varieties, many vegetable varieties (e.g. tomato, sweet pepper, lettuce, cabbage), some fruit and vine varieties, some forage crop varieties, and many ornamental plants would be rouled out.
- cells as the smallest living entity: just some few vegetable varieties (e.g. cabbage) and in the future potato and maize varieties would have to be rouled out.
- DNA as the smallest living entity: no consequences for the seed availability.

However, if restrictions for one or the other technique are made, it still has to be decided

- whether the use of all varieties once bred with these techniques should be prohibited (also as breeding material)
- or restrictions are made only for future cultivars and breeding programmes.

In addition, any regulation has to distinguish clearly between allowed and not allowed techniques and these differences must be controllable. An additional possibility to enhance the «quality» of organic plant breeding would be to certify breeders following a defined organic plant breeding programme.

The organic movement needs to find a clear and feasible way to define organic plant breeding with the aim to promote and accelerate the production of suitable plants for a sound organic agriculture.

## References

Lammerts van Bueren, E. T., Hulscher, M., Haring, M., Jongerden, J., van Mansvelt, J.D., den Nijs, A. P. M. and Ruivenkamp, G. T. P. (1999) Sustainable organic plant breeding. Final report: a vision, choices, consequences and steps. Louis Bolk Institute, Driebergen. 59 pp.

Wiethaler, C., Opperman, R. and Wyss, E. (2000) Organic plant breeding and biodiversity of cultural plants. Reports on the international conferences. Naturschutzbund Deutschland and Research Institute of Organic Agriculture. 115 pp.

**Table 2: Judgement of breeding and multiplication techniques considering either the plant, or the cell, or the DNA to be the smallest living entity.**

<b>Inducing variation</b>	Smallest living entity		
	Plant	Cell	DNA
Combination breeding, Crossing varieties, Bridging cross, Repeated back-crossing, Cutted/grafted style, Temperature treatment of the style	↑	↑	↑
F1 hybrid breeding, Unradiated mentor pollen technique	↗	↑	↑
Ovary/embryo culture, «In vitro» pollination, Anther/Microspore culture	↘	↑	↑
Polyploidisation, Somaclonal variation	↘	↗	↑
Hybridisation for CMS without restorer gene, Radiated mentor pollen technique	↓	↗	↑
Protoplast fusion	↓	↘	↑
Genetic engineering (is already prohibited)	↓	↓	↓

<b>Selection</b>	Plant	Cell	DNA
Mass selection, Pedigree selection, Site determined selection, Change in environment, Change in sowing time, Ear bed method			
Test crosses	↑	↑	↑
«In vitro» selection	↓	↗	↑
Marker-assisted selection	↓	↗	↑

<b>Multiplication</b>	Plant	Cell	DNA
Generative multiplication	↑	↑	↑
Vegetative multiplication	↑	↑	↑
Apomixis	↘	↑	↑
Meristem culture	↘	↗	↑
«In vitro» multiplication, Somatic embryogenesis	↓	↗	↑

Colours and arrows give the «degree of suitability»: ↑ = no problem, ↗ = ok, ↘ = not suitable but provisionally allowed, ↓ = not suitable.

## Imprint

Editor: Research Institute of Organic Agriculture (FiBL), Ackerstrasse, P.O. Box, CH-5070 Frick, Phone: +41 (0)62 865 72 72, Fax: +41 (0)62 865 72 73, E-mail: admin@fibl.ch, Homepage: www.fibl.ch  
 Research Institute of Organic Agriculture (FiBL) Berlin e.V., Rungestrasse 19, D-10179 Berlin, Phone: +49 (0)30 27 58 17 50, Fax: +49 (0)30 27 58 17 59, E-mail: Berlin@fibl.de

Authors: Eric Wyss (FiBL, Frick), Edith Lammerts van Bueren (Louis Bolk Institute, Driebergen), Marjolein Hulscher (Louis Bolk Institute, Driebergen), Michel Haring (University of Amsterdam)

Co-authors: Christine Arncken-Karutz (FiBL, Frick), Robert Haward (Soil Association, Bristol), François Lhopiteau (Institut Technique pour l'Agriculture Biologique, Paris), Eckard Reiners (Bioland Association Germany, Member of the Standards Committee of IFOAM), Klaus-Peter Wilbois (FiBL, Berlin)

Collaboration: Beat Keller (University of Zurich), Jos van Damme (Netherlands Institute of Ecology, Heteren), Peter van Dijk (Netherlands Institute of Ecology, Heteren), Michael Winzeler (Federal Research Station for Agroecology and Agriculture, Zurich-Reckenholz)

Editorial staff: Thomas Alföldi (FiBL, Frick)

Graphics: Daniel Gorba (FiBL, Frick)

Translation: Robert Haward (English version), Manuel Perret (French version), Jessamijn Miedema and Anne Bruinsma (Dutch version), Eric Wyss and Markus Bär (German version)

Cover photographs: Emasculation of a flower of cauliflower, Jan Velema (Vitalis Biologische Zaden BV)

This dossier is available in English, German, French, and Dutch

Price: 5 Euro

ISBN Nr. 3-906081-13-3

Sale: FiBL

© FiBL

# Glossary



Allele	One member of a pair or series of genes that occupy a specific position on a specific chromosome, the «form» in which a gene can occur in a plant.	Genotype	The genotype of an individual is the genetic make-up, determined by the alleles present on its chromosomes.
Callus	A callus is proliferating tissue consisting of non-differentiated cells.	Heterosis	It's the result of cross breeding two different and distant related plants of the same species. The offspring are more vigorous and often more disease resistant.
Chloroplasts	The green organelles of a plant cell that fix carbon dioxide using solar energy: photosynthesis. This provides the plant with energy carriers like sugars and ATP. They have their own DNA, which is predominantly inherited from the mother, but they still rely on genetic material stored in the nucleus.	Heterozygous	Heterozygous means an organism has two different alleles on its homologous chromosomes.
Chromosome	A chromosome is a continuous strand of duplex DNA, containing many genes. Most multicellular organisms have several chromosomes, which together comprise the genome. Sexually reproducing organisms have two copies of each chromosome, one from the each parent.	Homozygous	An organism is homozygous if it has the same allele on both of its homologous chromosomes.
Cross-pollination	The transfer of pollen from one plant to the flowers of a different plant.	Isozyme	All proteins with similar enzymatic activity.
Cytoplasm	The interior of a plant cell harbours many compartments: the nucleus, mitochondria, chloroplasts, vacuoles and many vesicular structures. The fluid cell in between these compartments is called the cytoplasm.	Marker	DNA fragment that is polymorphic in size or sequence. It can be used to differentiate between genetic material of varieties and species that are used in crosses.
DNA	DNA (deoxyribonucleic acid) is a double-stranded helix of nucleotides which carries the genetic information of a cell. It encodes the information for the production of proteins and is able to self-replicate.	Mitochondria	Mitochondria are the organelles inside cells where aerobic respiration occurs. They have their own DNA which is predominantly inherited from the mother, but they still rely on genetic material stored in the nucleus.
Enzyme	Enzymes are proteins that carry out biochemical reactions (or act as catalysts) inside the cell.	Phenotype	The phenotype is the combination of the observable characteristics of an organism. This should reflect the genotype, which is an organisms genetic composition. The phenotype results from the interaction of the genotype with the environment.
Gel electrophoresis	DNA is fragmented by restriction enzymes (molecular scissors) and transferred to an agarose gel. The DNA fragments move through the gel due to the electric field applied to the gel. The length of a DNA fragment determines its speed of movement through the gel. The resulting banded pattern of slow-moving and fast-moving DNA fragments is used to identify those DNA bands which are linked to the desired trait of a plant.	Polyploidy	The chromosomal constitution of a cell containing multiples of the normal number of chromosomes.
Gene	A gene is a hereditary unit that can be assigned of a sequence of DNA which occupies a specific position or locus in the genome. A gene codes for a protein or RNA which is responsible for (part of) a certain trait.	Protein	The translation product of a gene. It can be visualized as a string of amino acids, which are ordered through the definition of the genetic code of a particular gene.
		Protoplast	Isolated protoplasts are «naked» cells because the cell wall has been removed by either a mechanical or an enzymatic process.
		RNA	RNA (ribonucleic acid) is the messenger molecule that is transcribed from a gene and subsequently translated into protein.
		Self-pollination	The transfer of pollen from the anther to the style of the flower of same plant, resulting in «selfing» of a breeding line.